

简单紧凑的DB接线盒

- 小型节省空间
- 模块化架构，启用三个阶段模块
- 使用简单方便
- IP20的保护等级
- 夹紧NS35 导轨，或用螺丝安装在面板上
- 短路保护
- 每个模块的电缆穿线最长5*16mm

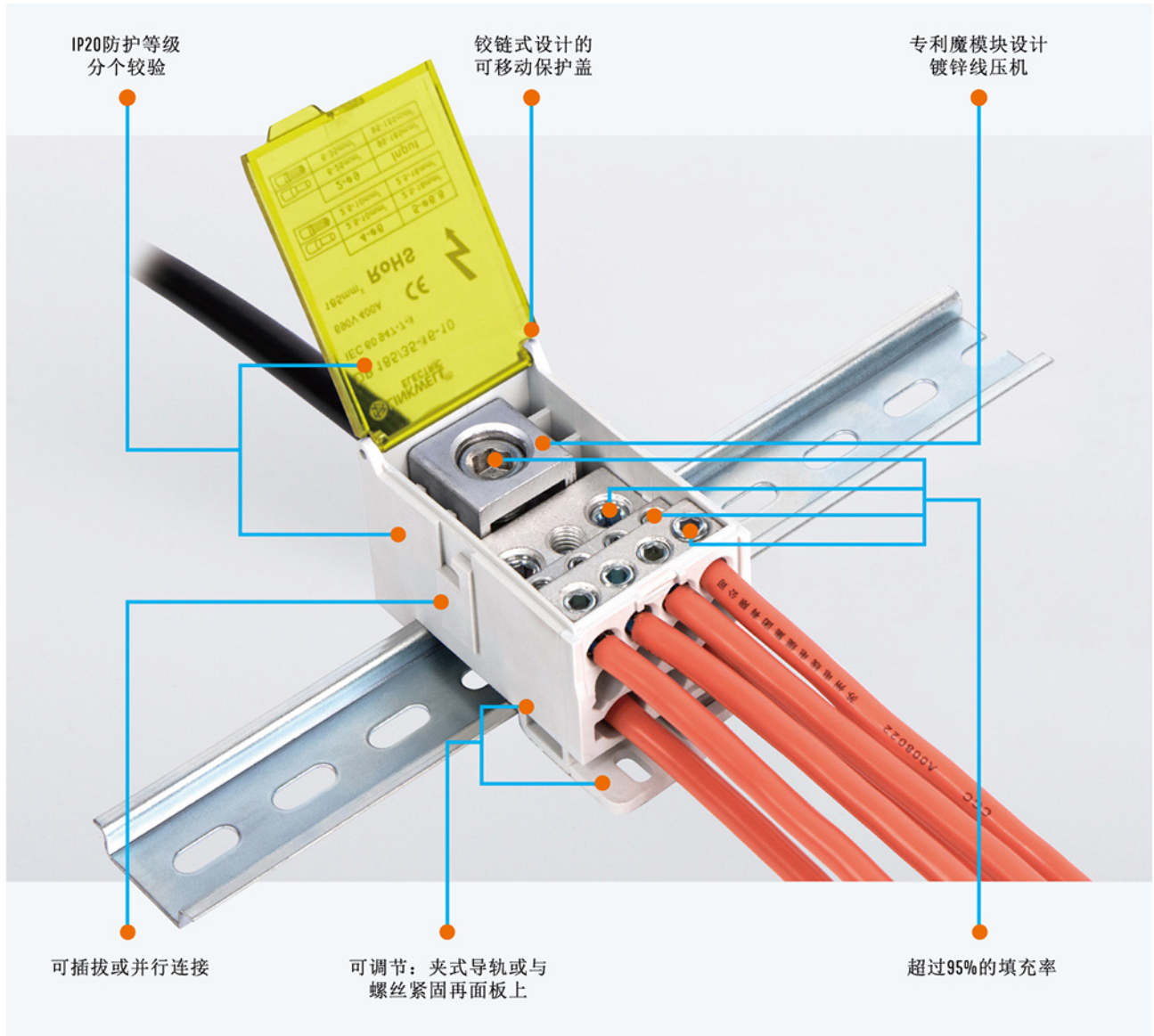

输入电缆连接方式

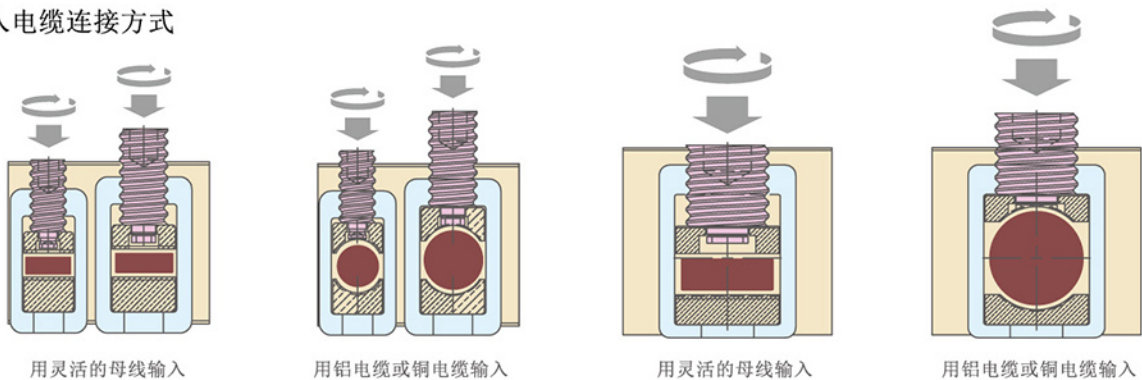



DB 16/6 3/4

CE RoHS

| 技术数据 | | | |
|--|--------------------|--------------|-------------|
| 最大电流 (A) | | 80A | |
| 外形尺寸 (mm) - 宽度/厚度/高度 NS35: 7.5/ NS35: 15 | | 66x30.2x48mm | NS35: 7.5 |
| 根据标准IEC 60 947-7-1的参数 | | | |
| 额定电压 (V) | V | 690 | |
| 额定电流 (A) | A | 80 | |
| 输入/输出额定截面、 | (mm ²) | 16/16-6 | |
| 额定脉冲电压/污染等级 | | 2.5kV/3 | |
| 阻燃等级根据标准UL94 | | V-0 | |
| 短路电流 (峰值) | | 22 | |
| 短路电流>1S | | 3 | |
| 输入 | | A | B |
| 输入端接线点的数量 | | 1 | |
| *e*单股硬导线H07V-U | (mm ²) | 2.5_16 | |
| *m*多股硬导线H07V-R | (mm ²) | 2.5_16 | |
| *f*软导线H07V-K | (mm ²) | 2.5_16 | |
| *f*带符合DIN46228-1管庄端头软导线H07V-R | (mm ²) | 2.5_16 | |
| *f*带符合DIN46228-1塑料套的管庄端头软导线H07V-R | (mm ²) | 2.5_16 | |
| 直径 | mm | 6.8 | |
| 拧紧力矩 | (Nm) | 1.5_3 | |
| 压接的螺钉规格 | | M6 | |
| 剥线长度 | (mm) | 9_12 | |
| 内六角扳手尺寸 | | SZS 1.0*6.5 | |
| 输出 | | A | B |
| 输出端接线点的数量 | | 3 | 4 |
| *e*单股硬导线H07V-U | (mm ²) | 2.5_16 | 2.5_6 |
| *m*多股硬导线H07V-R | (mm ²) | 2.5_16 | 2.5_6 |
| *f*软导线H07V-K | (mm ²) | 2.5_16 | 2.5_6 |
| *f*带符合DIN46228-1管庄端头软导线H07V-R | (mm ²) | 2.5_16 | 2.5_6 |
| *f*带符合DIN46228-1塑料套的管庄端头软导线H07V-R | (mm ²) | 2.5_16 | 2.5_6 |
| 直径 | mm | 6.8 | 4.5 |
| 拧紧力矩 | (Nm) | 1.5_3 | 0.8_1.5 |
| 压接的螺钉规格 | | M6 | M5 |
| 剥线长度 | (mm) | 9_12 | 9_12 |
| 螺丝起子尺寸/内六角扳手尺寸 | | SZS 1.0*6.5 | SZS 1.0*4.0 |
| UL/CSA参数 | | | |
| 电压/电流/导线尺寸 | UL | | |
| 电压/电流/导线尺寸 | CSA | | |
| 产品描述 | 颜色 | 型号 | 包装 |
| 铜电缆或铝电缆输入 | 白色PA | DB16/6 3/4 | 1 |
| | | DB16/6 3/4 | 1 |
| 软母排输入 | 灰色PA | | |
| 附件 | 螺丝刀 | 型号 | 型号 |
| | 开槽的 | SZS 1.0*4.0 | 8601011 |
| | 开槽的 | SZS 1.0*6.5 | 8601012 |
| | 内六角扳手7件套 | SK-S 3.0-8.0 | |



DB 35-16/16 1-1/8

CE RoHS

| 技术数据 | | | | |
|--|--------------------|-------------------|-----------|---------|
| 最大电流 (A) | | 125A | | |
| 外形尺寸 (mm) - 宽度/厚度/高度 NS35: 7.5/ NS35: 15 | | 75x40x50mm | NS35: 7.5 | |
| 根据标准 IEC 60 947-7-1 的参数 | | | | |
| 额定电压 (V) | V | 690 | | |
| 额定电流 (A) | A | 125 | | |
| 输入/输出额定截面、 | (mm ²) | 35-16/16 | | |
| 额定脉冲电压/污染等级 | | 2.5kV/3 | | |
| 阻燃等级根据标准 UL94 | | V-0 | | |
| 短路电流 (峰值) | | 30 | | |
| 短路电流·IS | | 4.2 | | |
| 输入 | | A | B | C |
| 输入端接线点的数量 | | 1 | 1 | |
| *e* 单股硬导线 H07V-U | (mm ²) | 10...35 | 6...16 | |
| *m* 多股硬导线 H07V-R | (mm ²) | 10...35 | 6...16 | |
| *f* 软导线 H07V-K | (mm ²) | 10...35 | 6...16 | |
| *f* 带符合 DIN46228-1 管庄端头软导线 H07V-R | (mm ²) | 10...35 | 6...16 | |
| *f* 带符合 DIN46228-1 塑料套的管庄端头软导线 H07V-R | (mm ²) | 10...35 | 6...16 | |
| 直径 | mm | 10 | 6.8 | |
| 拧紧力矩 | (Nm) | 3.5...5 | 1.5...3 | |
| 压接的螺钉规格 | | M8 | M6 | |
| 剥线长度 | (mm) | 14-15 | 9-12 | |
| 内六角扳手尺寸 | | SK-S 4.0 | SK-S 3.0 | |
| 输出 | | A | | |
| 输出端接线点的数量 | | 8 | | |
| *e* 单股硬导线 H07V-U | (mm ²) | 2.5...16 | | |
| *m* 多股硬导线 H07V-R | (mm ²) | 2.5...16 | | |
| *f* 软导线 H07V-K | (mm ²) | 2.5...16 | | |
| *f* 带符合 DIN46228-1 管庄端头软导线 H07V-R | (mm ²) | 2.5...16 | | |
| *f* 带符合 DIN46228-1 塑料套的管庄端头软导线 H07V-R | (mm ²) | 2.5...16 | | |
| 直径 | mm | 6.8 | | |
| 拧紧力矩 | (Nm) | 1.5...3 | | |
| 压接的螺钉规格 | | M6 | | |
| 剥线长度 | (mm) | 10...12 | | |
| 螺丝起子尺寸/内六角扳手尺寸 | | SK-S 3.0 | | |
| UL/CSA 参数 | | | | |
| 电压/电流/导线尺寸 | UL | | | |
| 电压/电流/导线尺寸 | CSA | | | |
| 产品描述 | 颜色 | 型号 | 包装 | 型号 |
| 铜电缆或铝电缆输入 | 白色 PA | DB 35-16/16 1-1/8 | 1 | 8602001 |
| | | DB 35-16/16 1-1/8 | 1 | 8602002 |
| 软母排输入 | 灰色 PA | DB 35-16/16 1-1/8 | 1 | 8602003 |
| | | DB 35-16/16 1-1/8 | 1 | 8602004 |
| 附件 | 螺丝刀 | 型号 | 型号 | |
| | 开槽的 | | | |
| | 开槽的 | SK-S 3.0 | 8601021 | |
| | 内六角扳手 7 件套 | SK-S 4.0 | 8601022 | |

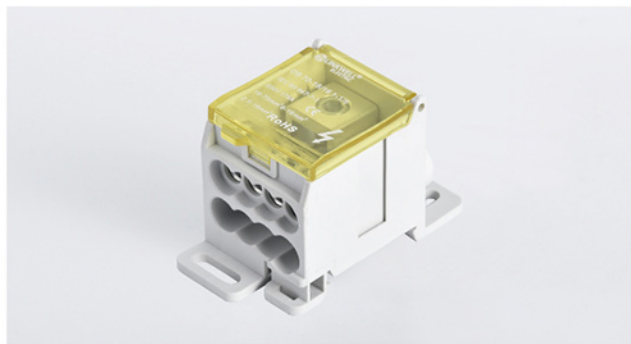

DB 70-16/16 1-1/8

CE RoHS

| 技术数据 | | | | |
|--|--------------------|------------------|-----------|---------|
| 最大电流 (A) | | 175A | | |
| 外形尺寸 (mm) - 宽度/厚度/高度 NS35: 7.5/ NS35: 15 | | 75x40x50mm | NS35: 7.5 | |
| 根据标准IEC 60 947-7-1的参数 | | | | |
| 额定电压 (V) | V | 690 | | |
| 额定电流 (A) | A | 175 | | |
| 输入/输出额定截面、 | (mm ²) | 70-16/16 | | |
| 额定脉冲电压/污染等级 | | 2.5kV/3 | | |
| 阻燃等级根据标准UL94 | | V-0 | | |
| 短路电流 (峰值) | | 30 | | |
| 短路电流>1S | | 11.8 | | |
| 输入 | | A | B | |
| 输入端接线点的数量 | | 1 | 1 | |
| *e*单股硬导线H07V-U | (mm ²) | 16...70 | 6...16 | |
| *m*多股硬导线H07V-R | (mm ²) | 16...70 | 6...16 | |
| *f*软导线H07V-K | (mm ²) | 16...70 | 6...16 | |
| *f*带符合DIN46228-1管庄端头软导线H07V-R | (mm ²) | 16...70 | 6...16 | |
| *f*带符合DIN46228-1塑料套的管庄端头软导线H07V-R | (mm ²) | 16...70 | 6...16 | |
| 直径 | mm | 12 | 6.8 | |
| 拧紧力矩 | (Nm) | 5 | 1.5...3 | |
| 压接的螺钉规格 | | M10 | M6 | |
| 剥线长度 | (mm) | 15-16 | 9-12 | |
| 内六角扳手尺寸 | | SK-S 5.0 | SK-S 3.0 | |
| 输出 | | A | | |
| 输出端接线点的数量 | | 10 | | |
| *e*单股硬导线H07V-U | (mm ²) | 2.5...16 | | |
| *m*多股硬导线H07V-R | (mm ²) | 2.5...16 | | |
| *f*软导线H07V-K | (mm ²) | 2.5...16 | | |
| *f*带符合DIN46228-1管庄端头软导线H07V-R | (mm ²) | 2.5...16 | | |
| *f*带符合DIN46228-1塑料套的管庄端头软导线H07V-R | (mm ²) | 2.5...16 | | |
| 直径 | mm | 6.8 | | |
| 拧紧力矩 | (Nm) | 1.5...3 | | |
| 压接的螺钉规格 | | M6 | | |
| 剥线长度 | (mm) | 10...12 | | |
| 螺丝起子尺寸/内六角扳手尺寸 | | SK-S 3.0 | | |
| UL/CSA参数 | | | | |
| 电压/电流/导线尺寸 | UL | | | |
| 电压/电流/导线尺寸 | CSA | | | |
| 产品描述 | 颜色 | 型号 | 包装 | 型号 |
| 铜电缆或铝电缆输入 | 白色PA | DB 70-16/6 1-1/8 | 1 | 8603001 |
| | | DB 70-16/6 1-1/8 | 1 | 8603002 |
| 软母排输入 | 灰色PA | DB 70-16/6 1-1/8 | 1 | 8603003 |
| | | DB 70-16/6 1-1/8 | 1 | 8603004 |
| 附件 | 螺丝刀 | 型号 | | 型号 |
| | 开槽的 | | | |
| | 开槽的 | SK-S 3.0 | | 8601021 |
| | 内六角扳手7件套 | SK-S 5.0 | | 8601023 |

尺寸图





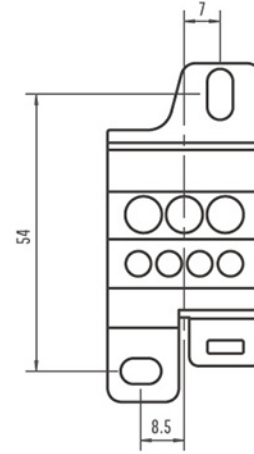



DB 16/6 3/4

| 公制 |   mm ² | | Φ | | N.m |
|---|---|----|-----|---|-----|
|  | 2.5...16 | ×1 | 6.8 |  | 3.0 |
|  | 2.5...6 | ×4 | 4.5 |  | 1.5 |
|  | 2.5...16 | ×2 | 6.8 |  | 3.0 |











DB 35-16/6 1-1/8

铜电缆或铝电缆输入

| 公制 |   mm ² | | Φ | | N.m |
|---|---|----|-----|---|-----|
|  | 10...35 | ×1 | |  | 5.0 |
|  | 6...16 | ×1 | 6.8 |  | 3.0 |
|  | 2.5...16 | ×8 | 6.8 |  | 3.0 |

软管输入





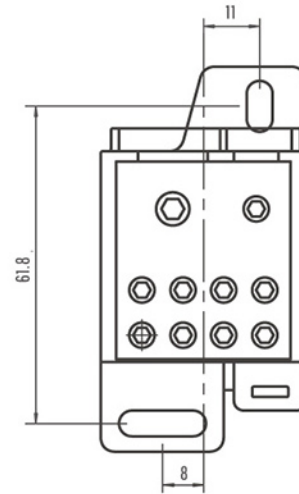



| 软管输入端 | | | | | |
|-------------------|--|--|--|--|--|
| 9×3×0.8 - 9×6×0.8 | | | | | |

| 公制 |   mm ² | | Φ | | N.m |
|---|---|----|-----|---|-----|
|  | 10...35 | ×1 | |  | 5.0 |
|  | 6...16 | ×1 | 6.8 |  | 3.0 |
|  | 2.5...16 | ×8 | 6.8 |  | 3.0 |











DB 70-16/6 1-1/8

铜电缆或铝电缆输入

| 公制 |   mm ² | | Φ | | N.m |
|---|---|----|-----|---|-----|
|  | 16...70 | ×1 | |  | 5.0 |
|  | 6...16 | ×1 | 6.8 |  | 3.0 |
|  | 2.5...16 | ×8 | 6.8 |  | 3.0 |

软管输入

| 软管输入端 | | | | | |
|---------------------|--|--|--|--|--|
| 13×3×0.5 - 13×6×0.5 | | | | | |

| 公制 |   mm ² | | Φ | | N.m |
|---|---|----|-----|---|-----|
|  | 16...70 | ×1 | |  | 5.0 |
|  | 6...16 | ×1 | 6.8 |  | 3.0 |
|  | 2.5...16 | ×8 | 6.8 |  | 3.0 |

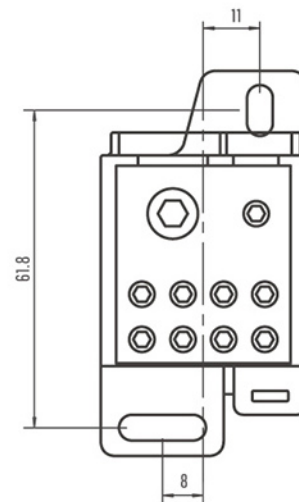



DB 120/35-16-10 1/2-5-4

CE RoHS

| 技术数据 | | | | |
|--|--------------------|-------------------------|-----------|----------|
| 最大电流 (A) | | 250A | | |
| 外形尺寸 (mm) - 宽度/厚度/高度 NS35: 7.5/ NS35: 15 | | 96x46.8x51.5mm | NS35: 7.5 | |
| 根据标准IEC 60 947-7-1的参数 | | | | |
| 额定电压 (V) | V | 690 | | |
| 额定电流 (A) | A | 250 | | |
| 输入/输出额定截面、 | (mm ²) | 120/35-16-10 | | |
| 额定脉冲电压/污染等级 | | 2.5kV/3 | | |
| 阻燃等级根据标准UL94 | | V-0 | | |
| 短路电流 (峰值) | | 51 | | |
| 短路电流·IS | | 24.5 | | |
| 输入 | | A | | |
| 输入端接线点的数量 | | 1 | | |
| *e*单股硬导线H07V-U | (mm ²) | 35...120 | | |
| *m*多股硬导线H07V-R | (mm ²) | 35...120 | | |
| *f*软导线H07V-K | (mm ²) | 35...120 | | |
| *f*带符合DIN46228-1管庄端头软导线H07V-R | (mm ²) | 35...120 | | |
| *f*带符合DIN46228-1塑料套的管庄端头软导线H07V-R | (mm ²) | 35...120 | | |
| 直径 | mm | 15 | | |
| 拧紧力矩 | (Nm) | 19 | | |
| 压接的螺钉规格 | | M12 | | |
| 剥线长度 | (mm) | 27...29 | | |
| 内六角扳手尺寸 | | SK-S 6.0 | | |
| 输出 | | A | B | C |
| 输出端接线点的数量 | | 2 | 5 | 4 |
| *e*单股硬导线H07V-U | (mm ²) | 2.5...35 | 2.5...16 | 2.5...10 |
| *m*多股硬导线H07V-R | (mm ²) | 2.5...35 | 2.5...16 | 2.5...10 |
| *f*软导线H07V-K | (mm ²) | 2.5...35 | 2.5...16 | 2.5...10 |
| *f*带符合DIN46228-1管庄端头软导线H07V-R | (mm ²) | 2.5...35 | 2.5...16 | 2.5...10 |
| *f*带符合DIN46228-1塑料套的管庄端头软导线H07V-R | (mm ²) | 2.5...35 | 2.5...16 | 2.5...10 |
| 直径 | mm | 9 | 6.8 | 6.1 |
| 拧紧力矩 | (Nm) | 3.5 | 2 | 2 |
| 压接的螺钉规格 | | M10 | M6 | M5 |
| 剥线长度 | (mm) | 10...12 | 10...12 | 10...12 |
| 螺丝起子尺寸/内六角扳手尺寸 | | SK-S 5.0 | SK-S 4.0 | SK-S 3.0 |
| UL/CSA参数 | | | | |
| 电压/电流/导线尺寸 | UL | | | |
| 电压/电流/导线尺寸 | CSA | | | |
| 产品描述 | 颜色 | 型号 | 包装 | 型号 |
| 铜电缆或铝电缆输入 | 白色PA | DB 120/35-16-10 1/2-5-4 | 1 | 8604001 |
| | | DB 120/35-16-10 1/2-5-4 | 1 | 8604002 |
| | | DB 120/35-16-10 1/2-5-4 | 1 | 8604003 |
| | | DB 120/35-16-10 1/2-5-4 | 1 | 8604004 |
| 软母排输入 | 灰色PA | | | |
| 附件 | 螺丝刀 | 型号 | | 型号 |
| | | SK-S 3.0 | | 8601021 |
| | | SK-S 4.0 | | 8601022 |
| | 内六角扳手6件套 | SK-S 5.0 | | 8601023 |
| | | SK-S 6.0 | | 8601024 |



DB 185/35-16-10 1/2-5-4









CE RoHS

| 技术数据 | | | | |
|--|--------------------|-------------------------|-----------|----------|
| 最大电流 (A) | | 400A | | |
| 外形尺寸 (mm) - 宽度/厚度/高度 NS35: 7.5/ NS35: 15 | | 96x46.8x51.5mm | NS35: 7.5 | |
| 根据标准IEC 60 947-7-1的参数 | | | | |
| 额定电压 (V) | V | 690 | | |
| 额定电流 (A) | A | 400 | | |
| 输入/输出额定截面、 | (mm ²) | 185/35-16-10 | | |
| 额定脉冲电压/污染等级 | | 2.5kV/3 | | |
| 阻燃等级根据标准UL94 | | V-0 | | |
| 短路电流 (峰值) | | 51 | | |
| 短路电流>IS | | 24.5 | | |
| 输入 | | A | | |
| 输入端接线点的数量 | | 1 | | |
| *e*单股硬导线H07V-U | (mm ²) | 95...185 | | |
| *m*多股硬导线H07V-R | (mm ²) | 95...185 | | |
| *f*软导线H07V-K | (mm ²) | 95...185 | | |
| *f*带符合DIN46228-1管庄端头软导线H07V-R | (mm ²) | 95...185 | | |
| *f*带符合DIN46228-1塑料套的管庄端头软导线H07V-R | (mm ²) | 95...185 | | |
| 直径 | mm | 19 | | |
| 拧紧力矩 | (Nm) | 25 | | |
| 压接的螺钉规格 | | M16 | | |
| 剥线长度 | (mm) | 27...29 | | |
| 内六角扳手尺寸 | | SK-S 8.0 | | |
| 输出 | | A | B | C |
| 输出端接线点的数量 | | 2 | 5 | 4 |
| *e*单股硬导线H07V-U | (mm ²) | 2.5...35 | 2.5...16 | 2.5...10 |
| *m*多股硬导线H07V-R | (mm ²) | 2.5...35 | 2.5...16 | 2.5...10 |
| *f*软导线H07V-K | (mm ²) | 2.5...35 | 2.5...16 | 2.5...10 |
| *f*带符合DIN46228-1管庄端头软导线H07V-R | (mm ²) | 2.5...35 | 2.5...16 | 2.5...10 |
| *f*带符合DIN46228-1塑料套的管庄端头软导线H07V-R | (mm ²) | 2.5...35 | 2.5...16 | 2.5...10 |
| 直径 | mm | 9 | 6.8 | 6.1 |
| 拧紧力矩 | (Nm) | 3.5 | 2 | 2 |
| 压接的螺钉规格 | | M10 | M6 | M5 |
| 剥线长度 | (mm) | 10...12 | 10...12 | 10...12 |
| 螺丝起子尺寸/内六角扳手尺寸 | | SK-S 5.0 | SK-S 4.0 | SK-S 3.0 |
| UL/CSA参数 | | | | |
| 电压/电流/导线尺寸 | UL | | | |
| 电压/电流/导线尺寸 | CSA | | | |
| 产品描述 | 颜色 | 型号 | 包装 | 型号 |
| 铜电缆或铝电缆输入 | 白色PA | DB 185/35-16-10 1/2-5-4 | 1 | 8605001 |
| | | DB 185/35-16-10 1/2-5-4 | 1 | 8605002 |
| 软母排输入 | 灰色PA | DB 185/35-16-10 1/2-5-4 | 1 | 8605003 |
| | | DB 185/35-16-10 1/2-5-4 | 1 | 8605004 |
| 附件 | 螺丝刀 | 型号 | | 型号 |
| | | SK-S 3.0 | | 8601021 |
| | | SK-S 4.0 | | 8601022 |
| | | SK-S 5.0 | | 8601023 |
| | | SK-S 8.0 | | 8601025 |
| | 内六角扳手6件套 | | | |

尺寸图









DB 120/35-16-10 1/2-5-4

铜电缆或铝电缆输入

| 公制 |  mm ² | | Φ | | N.m |
|---|---|----|-----|---|-----|
|  | 35...120 | ×1 | 9 |  | 19 |
|  | 2.5...35 | ×2 | 9 |  | 3.5 |
|  | 2.5...16 | ×5 | 6.8 |  | 2 |
|  | 2.5...10 | ×4 | 6.1 |  | 2 |

软管输入





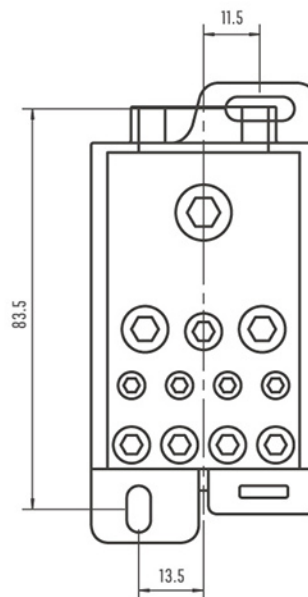



| 软管输入端 | |
|-------------------------|--|
| 15.5×2×0.8 - 15.5×6×0.8 | |

| 公制 |  mm ² | | Φ | | N.m |
|---|---|----|-----|---|-----|
|  | 35...120 | ×1 | 9 |  | 19 |
|  | 2.5...35 | ×2 | 9 |  | 3.5 |
|  | 2.5...16 | ×5 | 6.8 |  | 2 |
|  | 2.5...10 | ×4 | 6.1 |  | 2 |











DB 185/35-16-10 1/2-5-4

铜电缆或铝电缆输入

| 公制 |  mm ² | | Φ | | N.m |
|---|---|----|-----|---|-----|
|  | 95...185 | ×1 | 9 |  | 25 |
|  | 2.5...35 | ×2 | 9 |  | 3.5 |
|  | 2.5...16 | ×5 | 6.8 |  | 2 |
|  | 2.5...10 | ×4 | 6.1 |  | 2 |

软管输入

| 软管输入端 | |
|---------------------|--|
| 20×2×1.0 - 20×6×1.0 | |

| 公制 |  mm ² | | Φ | | N.m |
|---|---|----|-----|---|-----|
|  | 95...185 | ×1 | 9 |  | 25 |
|  | 2.5...35 | ×2 | 9 |  | 3.5 |
|  | 2.5...16 | ×5 | 6.8 |  | 2 |
|  | 2.5...10 | ×4 | 6.1 |  | 2 |

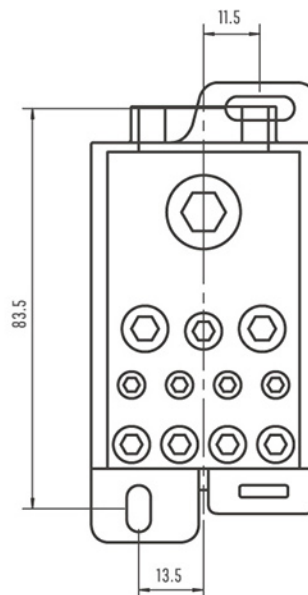



DB 185/35-16-10 1/2-5-4

阻燃: UL94-V0

CE RoHS

| 技术数据 | | | |
|--|--------------------|-----------------|-----------|
| 最大电流 (A) | | 125A | |
| 外形尺寸 (mm) - 宽度/厚度/高度 NS35: 7.5/ NS35: 15 | | 75.5x85x50mm | NS35: 7.5 |
| 根据标准 IEC 60 947-7-1 的参数 | | | |
| 额定电压 (V) | V | 690 | |
| 额定电流 (A) | A | 125 | |
| 输入/输出额定截面 | (mm ²) | 3×35/16 | |
| 额定脉冲电压/污染等级 | | 2.5kV/3 | |
| 阻燃等级根据标准UL94 | | V-0 | |
| 短路电流 (峰值) | | 30 | |
| 短路电流 >1S | | 11.8 | |
| 输入 | | A | |
| 输入端接线点的数量 | | 3×1 | |
| *e*单股硬导线 H07V-U | (mm ²) | 10...35 | |
| *m*多股硬导线 H07V-R | (mm ²) | 10...35 | |
| *f*软导线H07V-K | (mm ²) | 10...35 | |
| *f*带符合DIN46228-1管装端头软导线H07V-R | (mm ²) | 10...35 | |
| *f*带符合DIN46228-1塑料套的管装端头软导线H07V-R | (mm ²) | 10...35 | |
| 直径 | mm | 10 | |
| 拧紧力矩 | (Nm) | 1.5...5 | |
| 压接的螺钉规格 | | M8 | |
| 剥线长度 | (mm) | 14...15 | |
| 内六角型扳手尺寸 | | SK-S 4.0 | |
| 输出 | | A | |
| 输出端接线点的数量 | | 3×6 | |
| *e*单股硬导线 H07V-U | (mm ²) | 2.5...16 | |
| *m*多股硬导线 H07V-R | (mm ²) | 2.5...16 | |
| *f*软导线H07V-K | (mm ²) | 2.5...16 | |
| *f*带符合DIN46228-1管装端头软导线H07V-R | (mm ²) | 2.5...16 | |
| *f*带符合DIN46228-1塑料套的管装端头软导线H07V-R | (mm ²) | 2.5...16 | |
| 直径 | mm | 6.1 | |
| 拧紧力矩 | (Nm) | 3 | |
| 压接的螺钉规格 | | M6 | |
| 剥线长度 | (mm) | 10...12 | |
| 内六角型扳手尺寸 | | SK-S 3.0 | |
| UL/CSA 参数 | | | |
| 电压/电流/导线尺寸 | UL | | |
| 电压/电流/导线尺寸 | CSA | | |
| 订购数据描述 | | | |
| | 颜色 | 型号 | 包装 |
| 铜电缆或铝电缆输入 | 白色PA WH | DB 3P-35/16 1/6 | 1 |
| | | DB 3P-35/16 1/6 | 1 |
| 软母排输入 | 灰色PA GY | DB 3P-35/16 1/6 | 1 |
| | | DB 3P-35/16 1/6 | 1 |
| 附件 | | | |
| | 螺丝刀 | 型号 | 型号 |
| | 内六角型扳手件套 | SK-S 3.0 | 8601021 |
| | | SK-S 4.0 | 8601022 |



DB 3P-70/16 1/6

阻燃: UL94-V0

CE RoHS

| 技术数据 | | | |
|--|--------------------|-----------------|-----------|
| 最大电流 (A) | | 175A | |
| 外形尺寸 (mm) - 宽度/厚度/高度 NS35: 7.5/ NS35: 15 | | 75.5x85x50mm | NS35: 7.5 |
| 根据标准 IEC 60 947-7-1 的参数 | | | |
| 额定电压 (V) | V | 690 | |
| 额定电流 (A) | A | 175 | |
| 输入/输出额定截面 | (mm ²) | 3×70/16 | |
| 额定脉冲电压/污染等级 | | 2.5kV/3 | |
| 阻燃等级根据标准UL94 | | V-0 | |
| 短路电流 (峰值) | | 51 | |
| 短路电流 >1S | | 24.5 | |
| 输入 | | A | |
| 输入端接线点的数量 | | 3×1 | |
| *e*单股硬导线 H07V-U | (mm ²) | 16...70 | |
| *m*多股硬导线 H07V-R | (mm ²) | 16...70 | |
| *f*软导线H07V-K | (mm ²) | 16...70 | |
| *f*带符合DIN46228-1管装端头软导线H07V-R | (mm ²) | 16...70 | |
| *f*带符合DIN46228-1塑料套的管装端头软导线H07V-R | (mm ²) | 16...70 | |
| 直径 | mm | 12 | |
| 拧紧力矩 | (Nm) | 5 | |
| 压接的螺钉规格 | | M10 | |
| 剥线长度 | (mm) | 15...16 | |
| 内六角型扳手尺寸 | | SK-S 5.0 | |
| 输出 | | A | |
| 输出端接线点的数量 | | 3×6 | |
| *e*单股硬导线 H07V-U | (mm ²) | 2.5...16 | |
| *m*多股硬导线 H07V-R | (mm ²) | 2.5...16 | |
| *f*软导线H07V-K | (mm ²) | 2.5...16 | |
| *f*带符合DIN46228-1管装端头软导线H07V-R | (mm ²) | 2.5...16 | |
| *f*带符合DIN46228-1塑料套的管装端头软导线H07V-R | (mm ²) | 2.5...16 | |
| 直径 | mm | 6.1 | |
| 拧紧力矩 | (Nm) | 3 | |
| 压接的螺钉规格 | | M6 | |
| 剥线长度 | (mm) | 10...12 | |
| 内六角型扳手尺寸 | | SK-S 3.0 | |
| UL/CSA 参数 | | | |
| 电压/电流/导线尺寸 | UL | | |
| 电压/电流/导线尺寸 | CSA | | |
| 订购数据描述 | | | |
| | 颜色 | 型号 | 包装 |
| 铜电缆或铝电缆输入 | 白色PA WH | DB 3P-70/16 1/6 | 1 |
| | | DB 3P-70/16 1/6 | 1 |
| 软母排输入 | 灰色PA GY | DB 3P-70/16 1/6 | 1 |
| | | DB 3P-70/16 1/6 | 1 |
| 附件 | | | |
| | 螺丝刀 | 型号 | 型号 |
| | 内六角型扳手件套 | SK-S 3.0 | 8601021 |
| | | SK-S 5.0 | 8601023 |

尺寸图

DB 3P-35/16 1/6

铜电缆或铝电缆输入

| 公制 |  mm ² | | Φ | | N.m |
|---|---|-----|-----|---|-----|
|  | 10...35 | ×3 | 10 |  | 5 |
|  | 2.5...16 | ×18 | 6.1 |  | 3 |

软母排输入



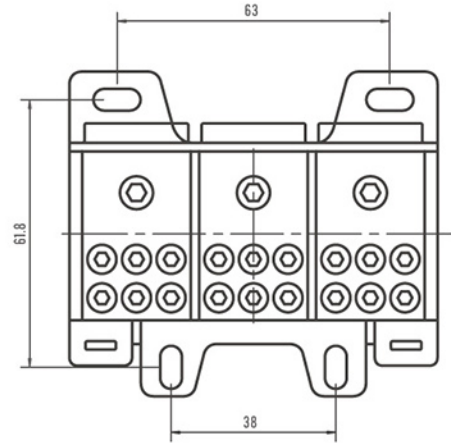

| 软母排输入端 | | | | | |
|-------------------|--|--|--|--|--|
| 9×3×0.8 - 9×6×0.8 | | | | | |

| 公制 |  mm ² | | Φ | | N.m |
|---|---|-----|-----|---|-----|
|  | 10...35 | ×3 | |  | 5 |
|  | 2.5...16 | ×18 | 6.1 |  | 3 |



DB 3P-70/16 1/6

铜电缆或铝电缆输入

| 公制 |  mm ² | | Φ | | N.m |
|---|---|-----|-----|---|-----|
|  | 16...70 | ×3 | 12 |  | 5 |
|  | 2.5...16 | ×18 | 6.1 |  | 3 |

软母排输入

| 软母排输入端 | | | | | |
|---------------------|--|--|--|--|--|
| 13×3×0.5 - 13×6×0.5 | | | | | |

| 公制 |  mm ² | | Φ | | N.m |
|---|---|-----|-----|---|-----|
|  | 16...70 | ×3 | |  | 5 |
|  | 2.5...16 | ×18 | 6.1 |  | 3 |

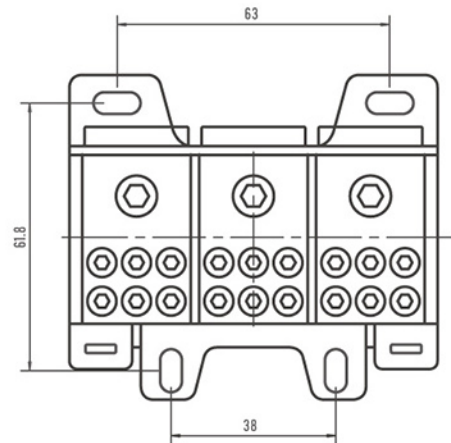

安装示意图

DB 16/6 3/4

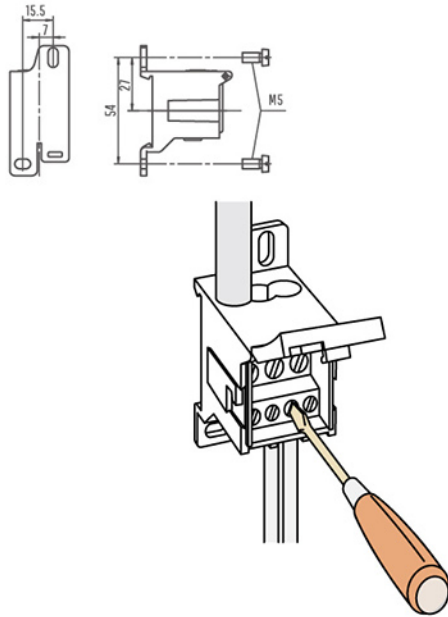

DB 35-16/6 1-1/8
DB 70-16/6 1-1/8

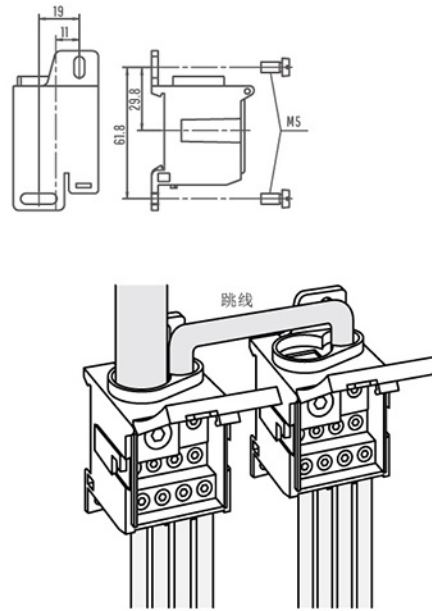

DB 120/35-16-10 1/2-5-4
DB 185/35-16-10 1/2-5-4

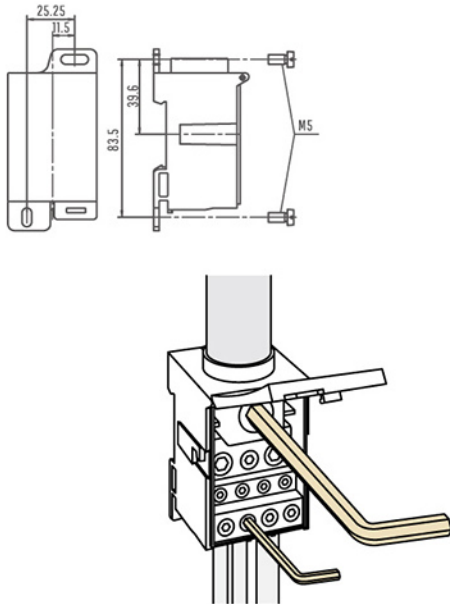

DB 3P-35/16 1/6
DB 3P-70/16 1/6

